

Article number: 0101128  
 Description: Retaining ring A 160 DIN 471  
 Spring steel  
 Note: Fitted with ZGA pilers

## Measures

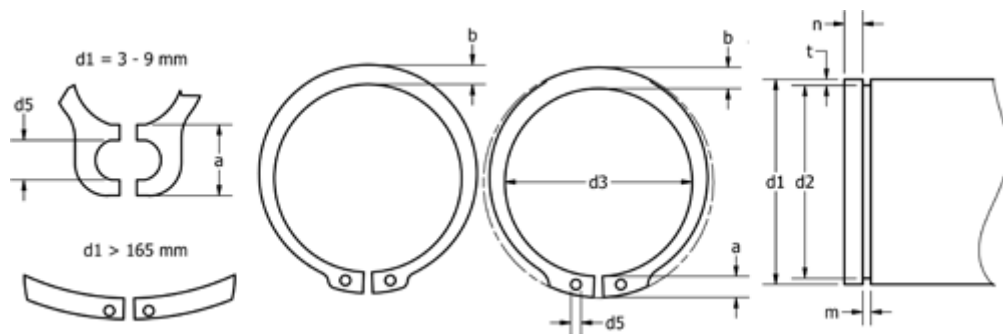

a max	= 13.3	FN kN	= 206.0	s	= 4.00
AN mm <sup>2</sup>	= 1237.0	FRg kN	= 52.20	t	= 2.50
b	= 122.0	FR kN	= 349.00	tol	= -0.63
d1	= 160	g	= 4.0	tol	= -0.10
d2	= 155.0	K kN-mm	= 806.00	tol	= +0,63-1,50
d3	= 151.0	m min	= 4.15	Tong	= ZGA-5
d5 min	= 4.0	n abl x 1000	= 3.0	Weight kg/1000	= 150.000
Description	= A160	Nominal drive	= 7.5		